



Signal® Mirror Installation Instructions

Chevy Express 1997-2002, GMC Savana (Cargo Van) 1997-2002



THE safety accessory of the 21st Century.™

P/N 210-0013-0

Rev C2 6-24-04, GG

© 2002 Muth Mirror Systems, LLC.

Note: Professional Installation Recommended

Warranty does not cover damage to the vehicle or mirror housing due to improper installation. The following installation instructions are to be considered as a guide only. Door removal procedures, indicator wire color and location may have changed since publication of these instructions. The installer is responsible for any damage that may occur during installation.

INCLUDED ITEMS:

- 1 left and 1 right *Signal*[®] mirror
- 1 left and 1 right wire harness
- 2 wire taps
- 2 ring connectors
- 1 instruction manual

REQUIRED TOOLS:

- Ratchet with extension or ratcheting screwdriver
- 10mm socket
- 8mm socket
- Small slotted screwdriver
- Medium Philips screwdriver
- Needle nose pliers
- Small pry bar, Heater Gun
- Gopher wire
- Electrical tape
- Wire crimper and stripper
- Multimeter
- Sturdy gloves
- Safety glasses or goggles

Please read instructions prior to installation.

PROBLEMS OR QUESTIONS?

Technical Assistance is available by calling
Muth Mirror Systems Technicians at:

1-800-844-6616

Monday through Friday
Between 8:00 a.m. and 5:00 p.m. CST

Or through the Muth web site:

www.muthco.com

Or via E-mail: techsupport@muthco.com

Mirror Housing Removal

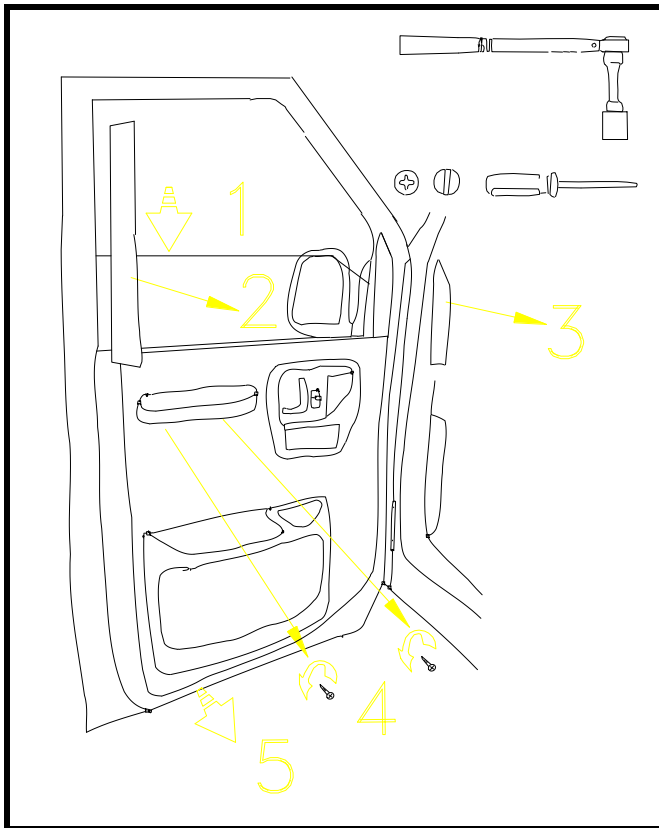

1. Lower window.
2. Remove the long window molding by unsnapping it from the door.
3. Unsnap the small triangular molding, exposing the mirror mounting screws.
4. Remove the two screws located behind the arm rest.
5. Remove the door panel by carefully pulling away from the door.

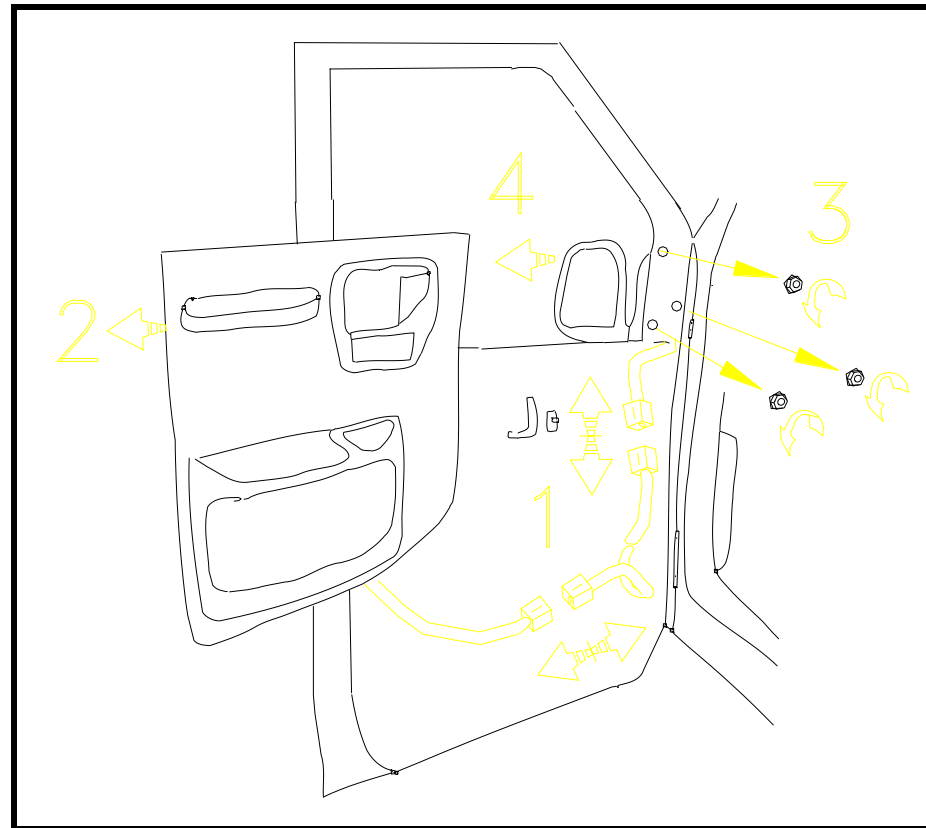

1. Unplug the connectors to the control panel, mirror, and the door light.
2. Remove the door panel from the door.
3. Secure mirror with one hand. Proceed cautiously to avoid dropping articles into the door panel. Remove the 3 mirror mounting nuts.
4. Remove mirror from door.

Mirror Replacement

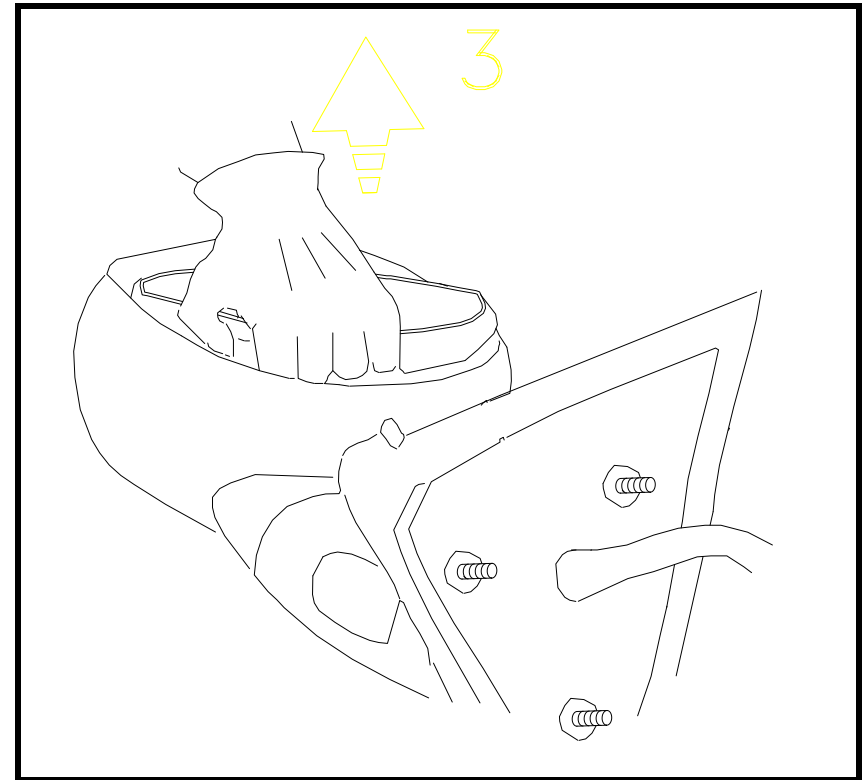
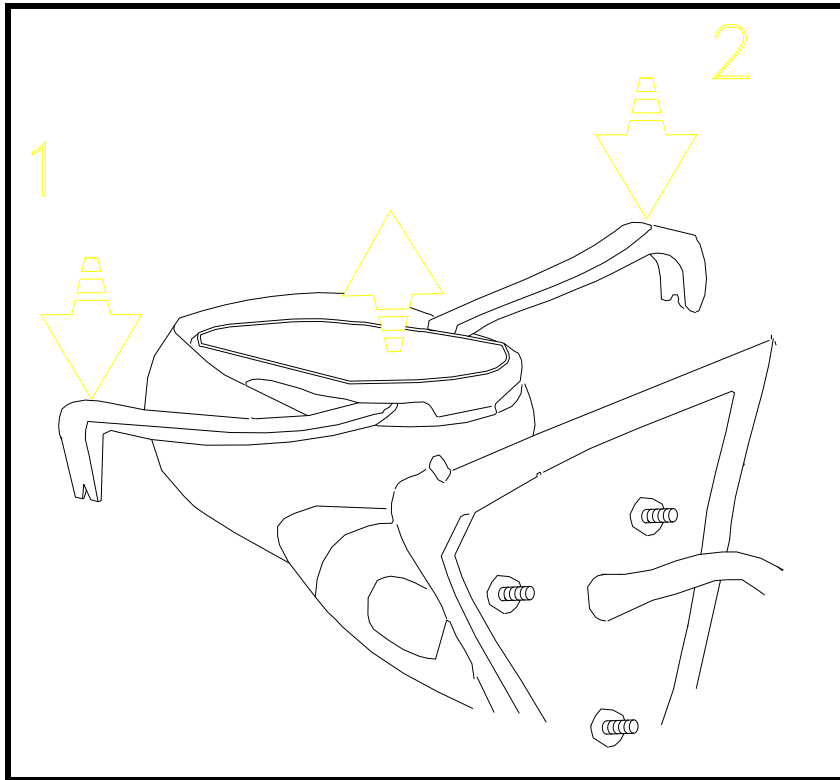

Caution: Safety glasses and sturdy gloves are recommended for the following steps.

1. Place the mirror housing on a clean level surface. Push on the outer edge of the mirror to manually pivot it fully outward so a small pry bar can be inserted under its inner edge. Apply gentle pressure with the pry bar until the mirror backing plate begins to unsnap from the motor.
2. Move the pry bar around the mirror and pry again until the mirror backing plate further unsnaps from the motor.

3. Pull the mirror off of the motor. Some force may be required to free any remaining snaps but it should not be excessive. If you can not remove the mirror without excessive force, apply the pry bar further around its edge to loosen more snaps. Then try again.

NOTE: If you have heated mirrors disconnect the wires when you remove the mirror. The polarity for the heaters is reversible so it is not necessary to label the wires.

Mirror Replacement Continues

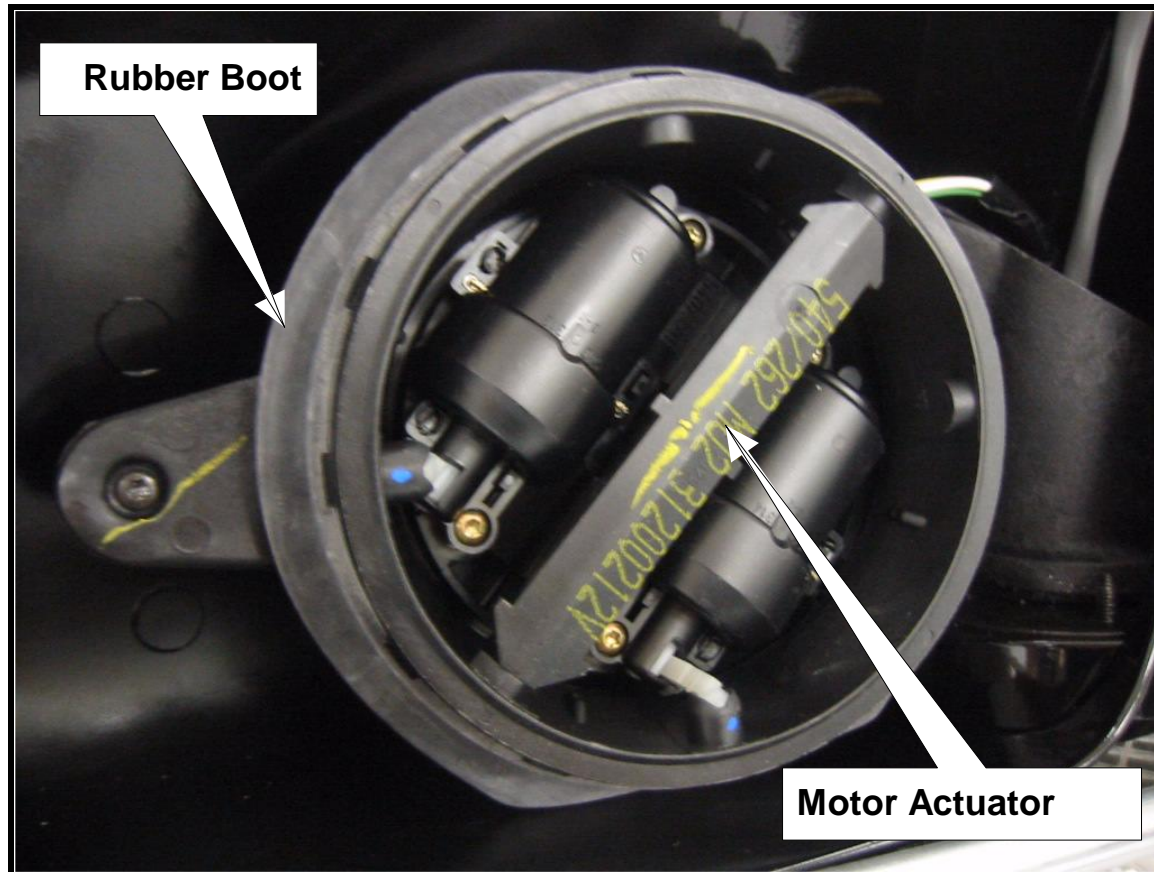

For both driver and passenger side mirrors, remove the rubber boot around the motor actuator PRIOR to installing the *Signal*® mirror into the mirror housing. **NOTE: Permanent removal of rubber boot, by pulling it over the motor, is required for this application and will not negatively affect operation or durability, per the mirror motor manufacturer.**

Mirror Replacement Continues

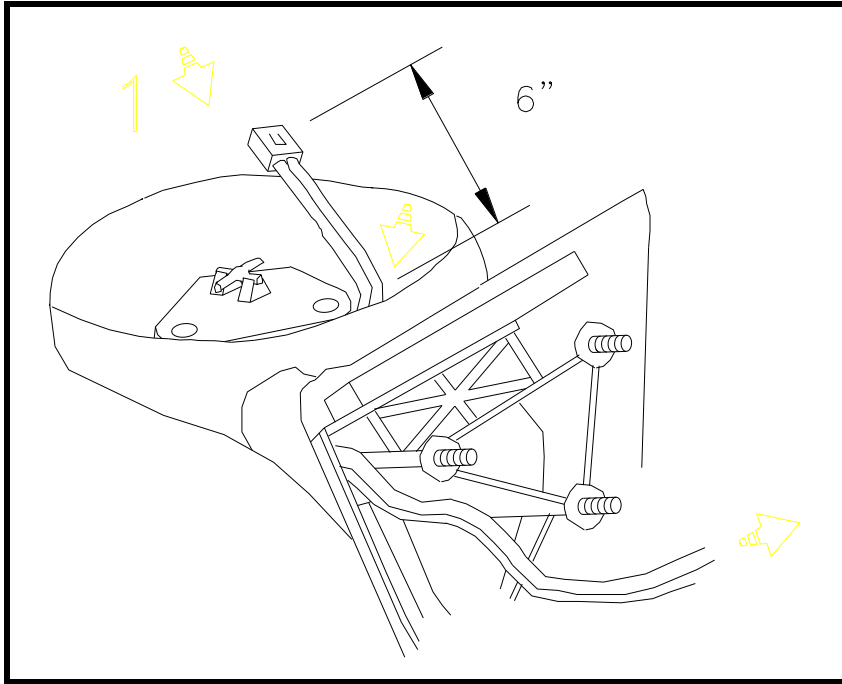

1. Unsnap the access panel at the bottom of the mirror housing with a small screwdriver.
2. Pull back the rubber insulation on the mirror mounting frame to expose the wire routing passage.
- 3) Locate the correct *Signal*[®] mirror harness (short for driver side and long for passenger side) and slide the end with no connector through the routing passage (from the inside of the mirror housing) and through the hole in the rubber insulation. Leave about 6 inches of slack in the harness near the motor pack. Replace the access panel.

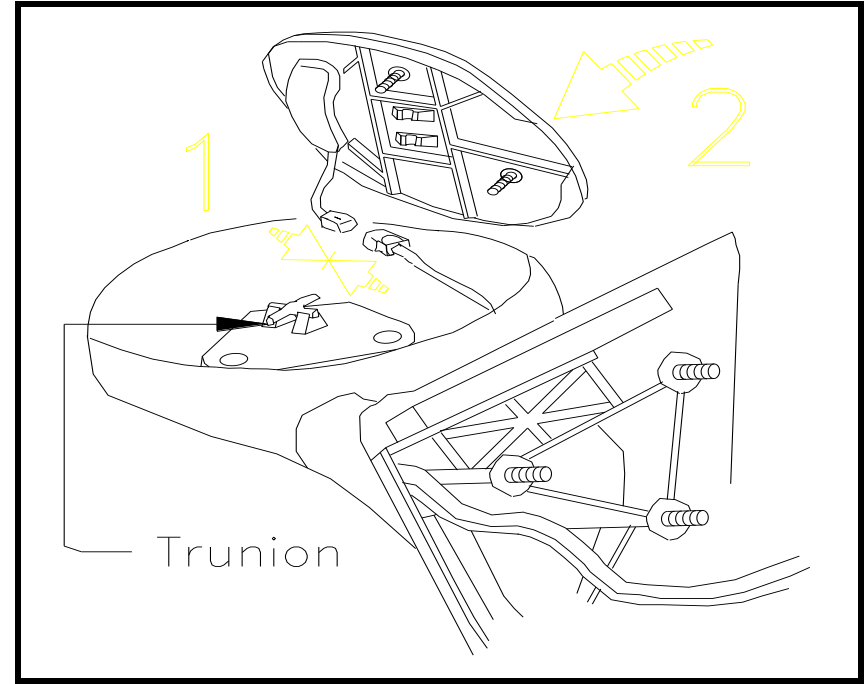

Caution: Safety glasses and sturdy gloves are recommended for the following steps

1. Connect the *Signal*[®] mirror leads to the harness. (If you have heated mirrors, connect the wires to the heater terminals at this time.)
2. Place the *Signal*[®] mirror over the motor pack.

3. Place the palm of your hand on the center of the glass and press firmly until you hear the snaps engage onto the motor puck. Press on the top, bottom and both sides of the mirror to ensure complete attachment to the motor puck. (Mirror should be pivoted through its full range of travel during this step.)

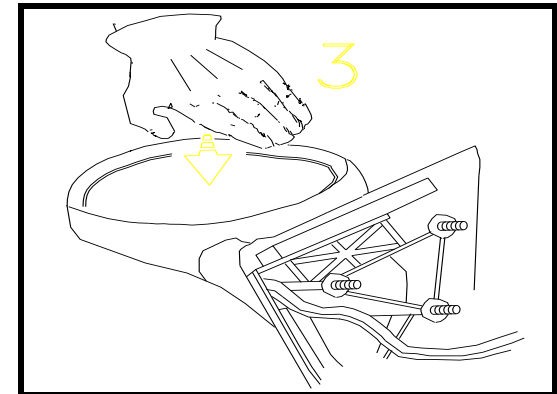

Mirror Housing Attachment

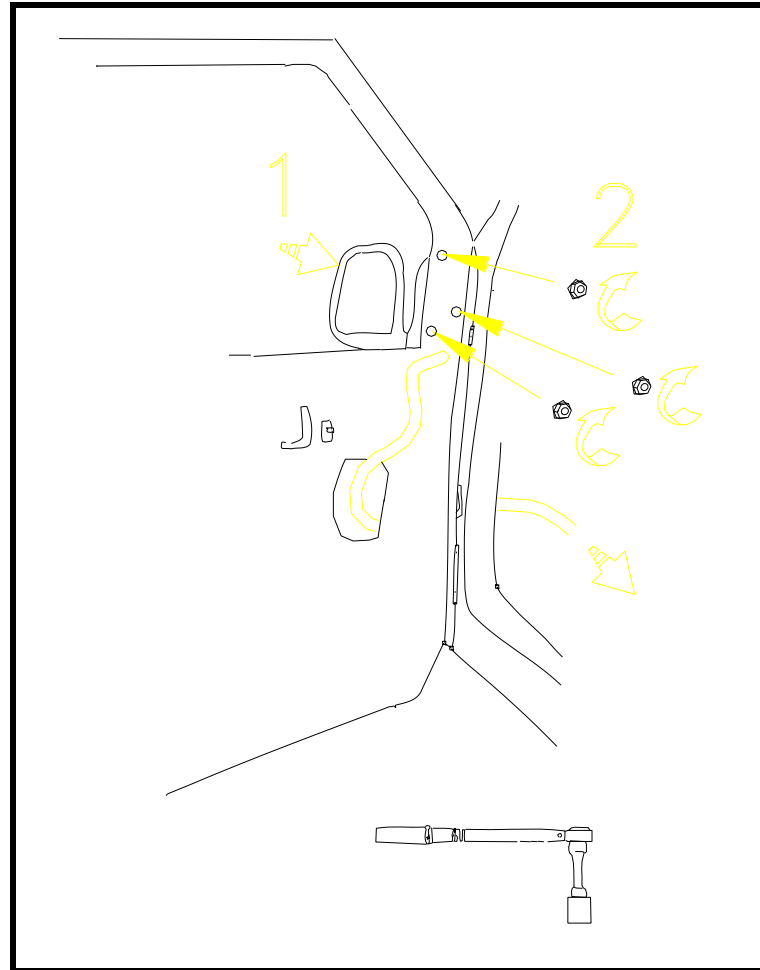

1. Feed wires into door and set mirror in place.
2. Attach mirror with original 3 nuts. Do not over tighten.
3. Pass *Signal*[®] mirror harness through the rubber boot between the door and the vehicle.
4. Unsnap the long carpet trim molding from the base of the door opening.

Wiring

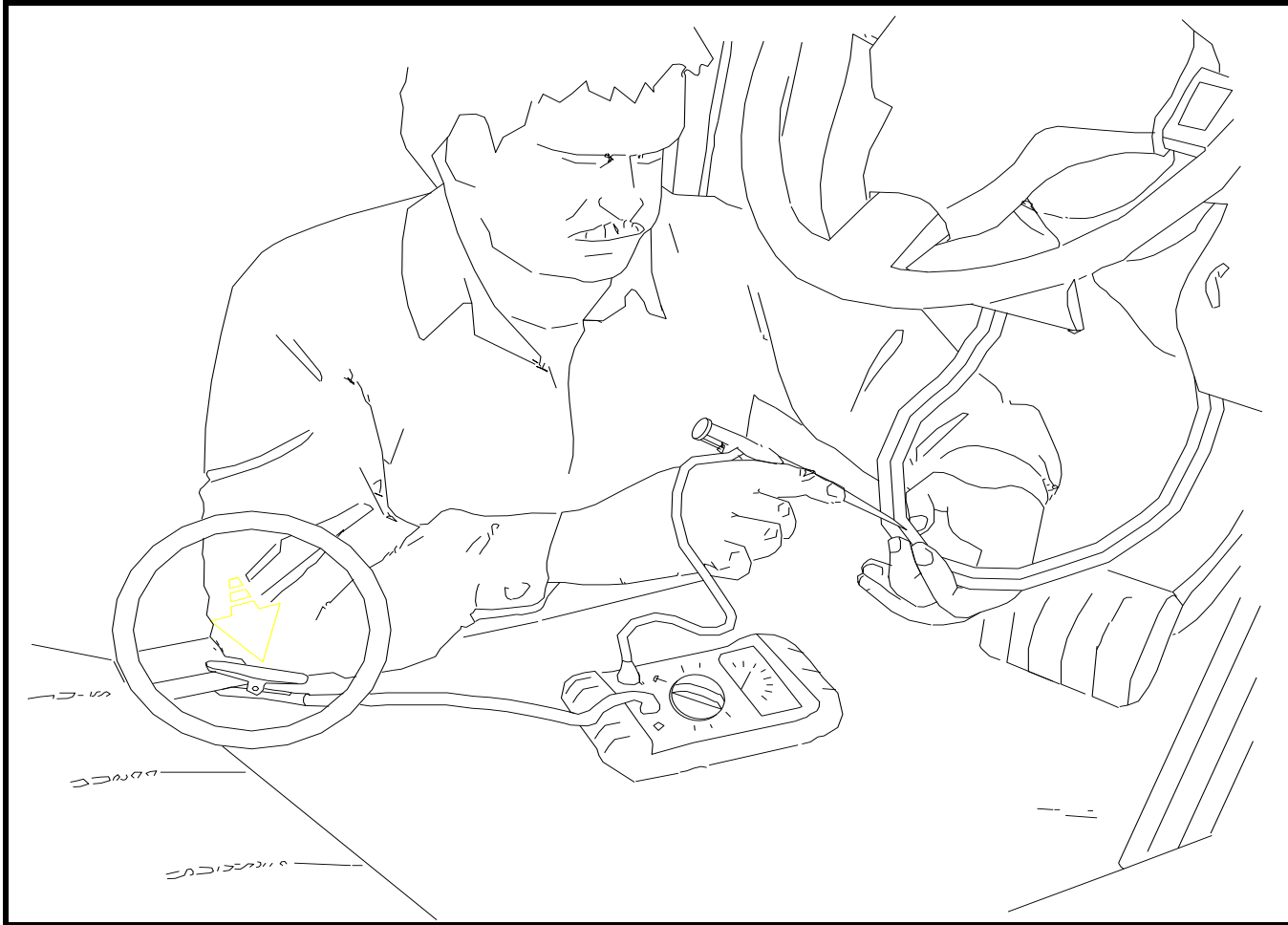

1. Find the bundle of wires just to the left and below the steering column. Locate the **Light Blue** wire. Turn the ignition key so that electrical power is on and activate the driver side turn indicator. Probe the **Light Blue** wire to verify that flashing turn indicator power is present. Deactivate the turn indicator and depress the brake to make sure you have not located the rear turn wire. Label that wire as front, ***driver side turn***.
2. Locate the **Dark Blue** wire and activate the passenger side turn indicator. Probe the **Dark Blue** wire to verify that flashing turn indicator power is present. Deactivate the turn indicator and depress the brake to make sure you have not located the rear turn wire. Label that wire as front, ***passenger side turn***.

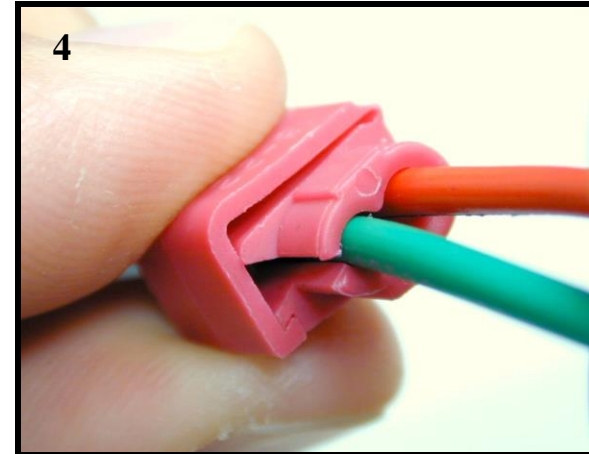
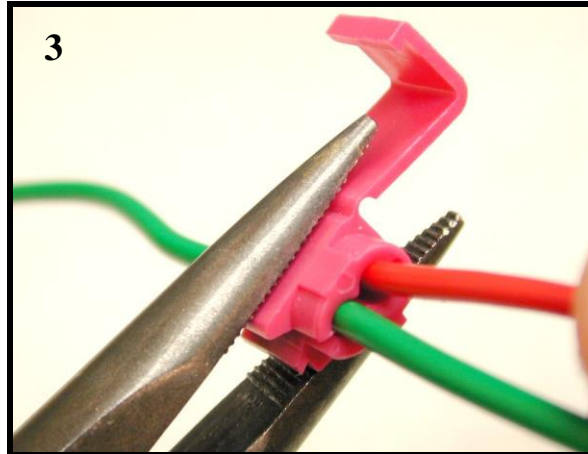
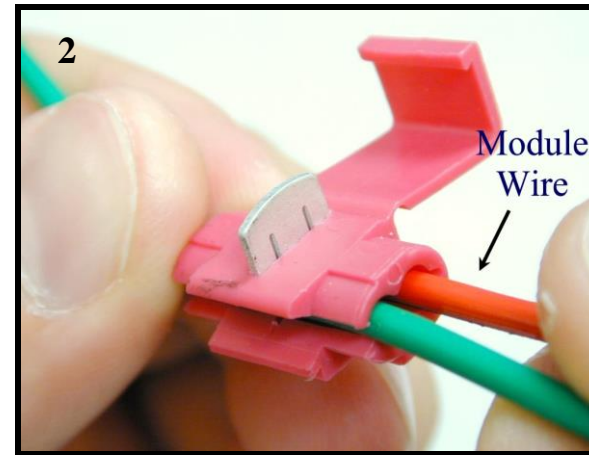
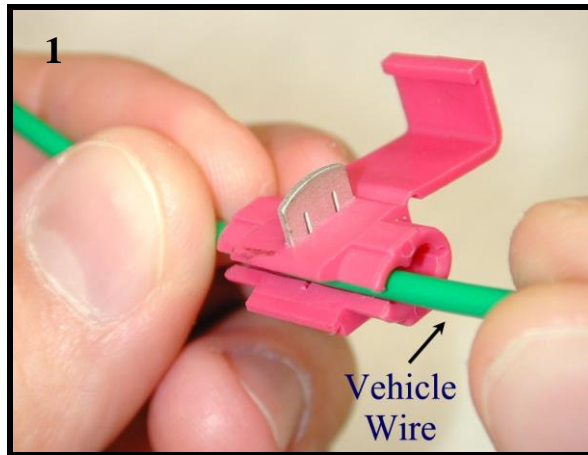

USE THE INCLUDED WIRE TAPS AND FOLLOW THE FOUR STEPS ABOVE TO SPLICE INTO THE TURN INDICATOR WIRES

1. Make sure the harnesses are routed securely under the dash and enough slack is left for splicing.
2. Splice the RED wire from the driver side harness into the LIGHT BLUE WIRE previously labeled '*driver side turn*'.
3. Splice the RED wire from the passenger side harness into the DARK BLUE WIRE previously labeled '*passenger side turn*'.
4. Strip and twist together the ends of the black wires from each harness. Crimp them together in the supplied ring connector and ground to a suitable nearby location on the metal framework of the vehicle.
5. Activate each turn indicator to verify that the *Signal*[®] mirrors are working.
6. Replace any door accessories, door panels, plastic moldings, and trim pieces.

